

arrow

ENIGMA COLLECTION FOR FLOORS, WALLS & CEILINGS



JAMIE BECKWITH®
COLLECTION

1. PATTERN AND REPEAT

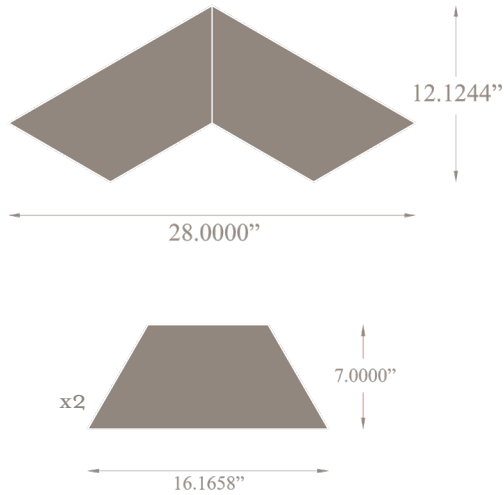

2. LAYOUT SUGGESTIONS

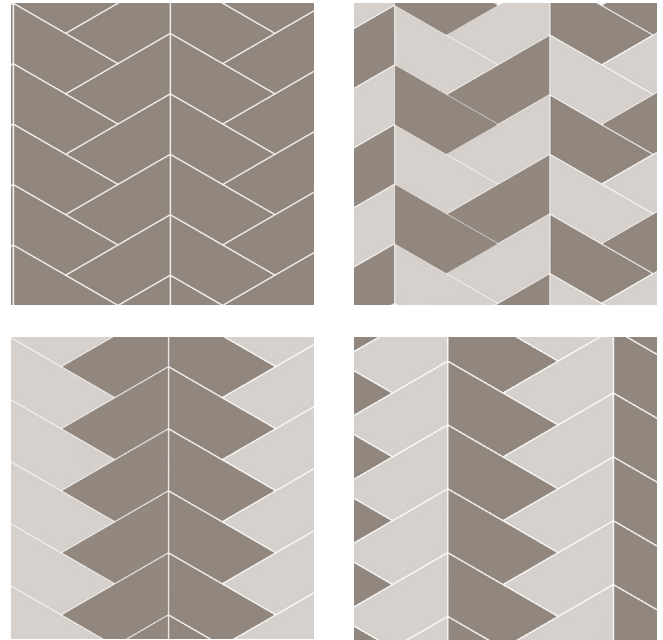

SPECIFICATIONS

WOOD TILE CONSTRUCTION:

Engineered wood.
4mm wear layer over 9 ply substrate.

THICKNESS:

5/8 inches.

REPEAT:

2 Tiles: 1.178 SF

BOX QUANTITY:

24.738 SF per box.
42 tiles total per box/ 21 repeats.

COVERAGE PER TILE:

.589 SF per tile.

INSTALLATION:

Glue down. (See installation guidelines)
Wood tiles are NOT provided on a mesh or panel backing.

USAGE:

Warranted for Commercial or Residential floors, walls & ceilings.
Not suitable for areas exposed to running water: inside showers, etc.
Not suitable for outdoor applications.

LEADTIME:

6-8 weeks for production.
Expedited options available upon request for an upcharge.

PRICING:

Varies by pattern & wood species.
Multiple stain selections do not affect pricing.

FIRE RATING:

Class C. (Class B available upon request)

STAINING SYSTEM:

Rubio Monocoat hard oil finish - no VOC.
Available unfinished.

LEED CREDITS:

2009 NC/CI MR Credit 5 - Regional Materials
2009 NC/CI IEQ Credit 4.1-4.4 - Low Emitting Finish

***This product may contribute to the achievement of LEED credits, although JBC makes no guarantees of representation of such.

CAD PATTERNS AVAILABLE UPON REQUEST.

Contact your local JBC representative.

3. SPECIES



Plain White Oak

Walnut



Quarter White

4. STAINS

AVAILABLE ON WHITE OAK SPECIES



Polished Amber

Dolphin

Smokey Quartz

Black Onyx

Grey Moonstone

Pickled Pearl

Mist

Gris

Slate

Sapphire

AVAILABLE ON WALNUT SPECIES:

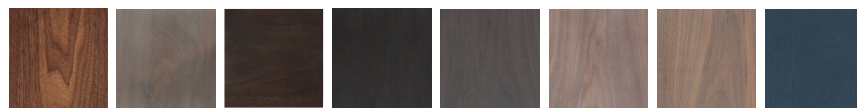

Polished Amber

Dolphin

Smokey Quartz

Black Onyx

Grey Moonstone

Pickled Pearl

Mist

Sapphire

1. PATTERN AND REPEAT

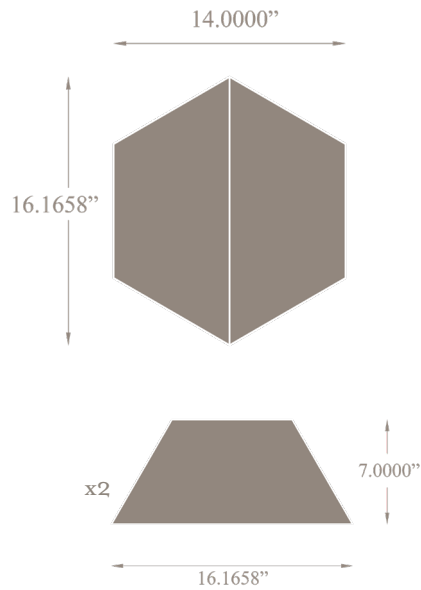

2. LAYOUT SUGGESTIONS

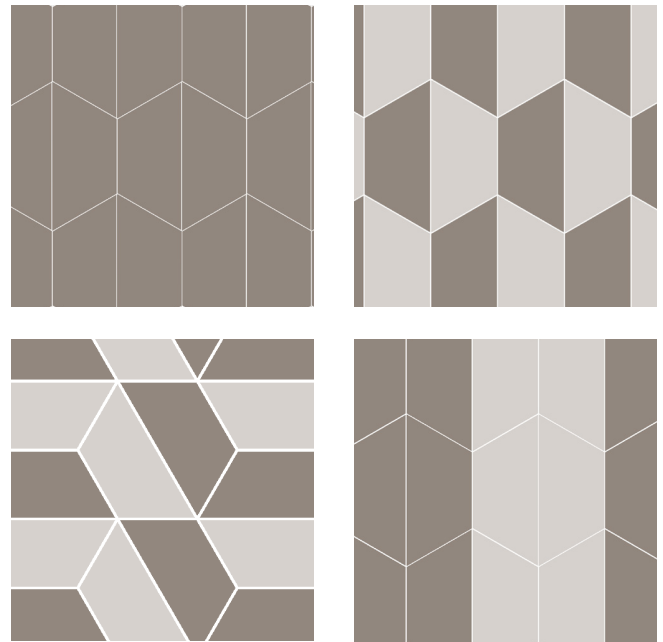

SPECIFICATIONS

WOOD TILE CONSTRUCTION:

Engineered wood.
4mm wear layer over 9 ply substrate.

THICKNESS:

5/8 inches.

REPEAT:

2 Tiles: 1.178 SF

BOX QUANTITY:

24.738 SF per box.
42 tiles total per box/ 21 repeats.

COVERAGE PER TILE:

.589 SF per tile.

INSTALLATION:

Glue down. (See installation guidelines)
Wood tiles are NOT provided on a mesh or panel backing.

USAGE:

Warranted for Commercial or Residential floors, walls & ceilings.
Not suitable for areas exposed to running water: inside showers, etc.
Not suitable for outdoor applications.

LEADTIME:

6-8 weeks for production.
Expedited options available upon request for an upcharge.

PRICING:

Varies by pattern & wood species.
Multiple stain selections do not affect pricing.

FIRE RATING:

Class C. (Class B available upon request)

STAINING SYSTEM:

Rubio Monocoat hard oil finish - no VOC.
Available unfinished.

LEED CREDITS:

2009 NC/CI MR Credit 5 - Regional Materials
2009 NC/CI IEQ Credit 4.1-4.4 - Low Emitting Finish

***This product may contribute to the achievement of LEED credits, although JBC makes no guarantees of representation of such.

CAD PATTERNS AVAILABLE UPON REQUEST.

Contact your local JBC representative.

3. SPECIES



Plain White Oak

Walnut



Quarter White

4. STAINS

AVAILABLE ON WHITE OAK SPECIES



Polished Amber

Dolphin

Smokey Quartz

Black Onyx

Grey Moonstone

Pickled Pearl

Mist

Gris

Slate

Sapphire

AVAILABLE ON WALNUT SPECIES:

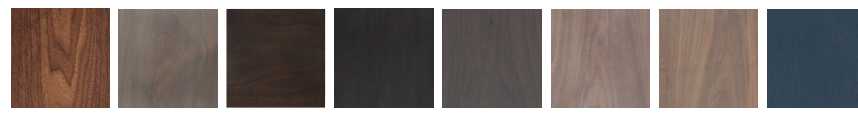

Polished Amber

Dolphin

Smokey Quartz

Black Onyx

Grey Moonstone

Pickled Pearl

Mist

Sapphire

sextant

ENIGMA COLLECTION FOR FLOORS, WALLS & CEILINGS



JAMIE BECKWITH®
COLLECTION

1. PATTERN AND REPEAT

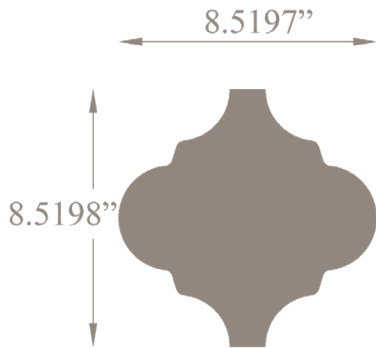

2. LAYOUT SUGGESTIONS

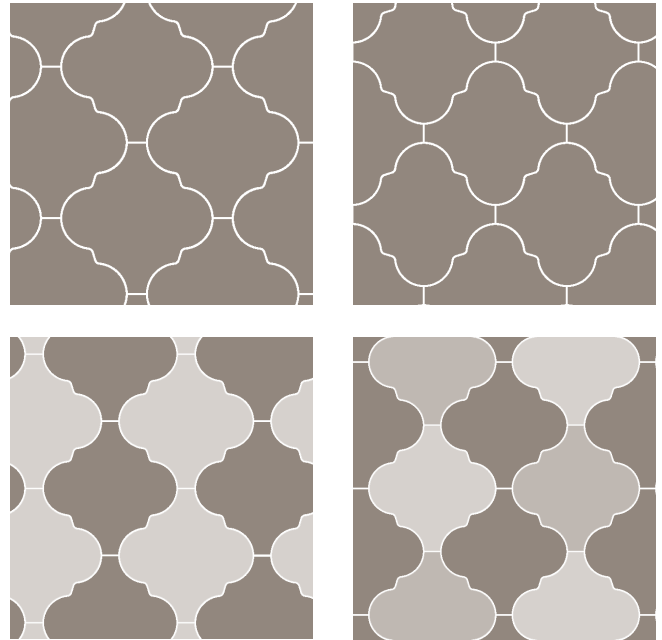

SPECIFICATIONS

WOOD TILE CONSTRUCTION:

Engineered wood.
4mm wear layer over 9 ply substrate.

THICKNESS:

5/8 inches.

REPEAT:

N/A

BOX QUANTITY:

22.62 SF per box.
78 tiles total per box.

COVERAGE PER TILE:

.29 SF per tile.

INSTALLATION:

Glue down. (See installation guidelines)
Wood tiles are NOT provided on a mesh or panel backing.

USAGE:

Warranted for Commercial or Residential floors, walls & ceilings.
Not suitable for areas exposed to running water: inside showers, etc.
Not suitable for outdoor applications.

LEADTIME:

6-8 weeks for production.
Expedited options available upon request for an upcharge.

PRICING:

Varies by pattern & wood species.
Multiple stain selections do not affect pricing.

FIRE RATING:

Class C. (Class B available upon request)

STAINING SYSTEM:

Rubio Monocoat hard oil finish - no VOC.
Available unfinished.

LEED CREDITS:

2009 NC/CI MR Credit 5 - Regional Materials
2009 NC/CI IEQ Credit 4.1-4.4 - Low Emitting Finish

***This product may contribute to the achievement of LEED credits, although JBC makes no guarantees of representation of such.

CAD PATTERNS AVAILABLE UPON REQUEST.

Contact your local JBC representative.

3. SPECIES



Plain White Oak

Walnut



Quarter White

4. STAINS

AVAILABLE ON WHITE OAK SPECIES



Polished Amber

Dolphin

Smokey Quartz

Black Onyx

Grey Moonstone

Pickled Pearl

Mist

Gris

Slate

Sapphire

AVAILABLE ON WALNUT SPECIES:

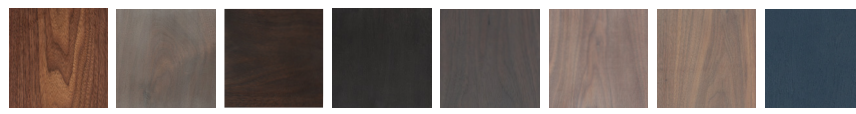

Polished Amber

Dolphin

Smokey Quartz

Black Onyx

Grey Moonstone

Pickled Pearl

Mist

Sapphire

sextant mini

ENIGMA COLLECTION FOR FLOORS, WALLS & CEILINGS



JAMIE BECKWITH®
COLLECTION

1. PATTERN AND REPEAT

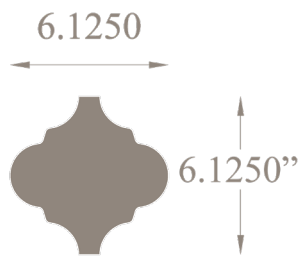

2. LAYOUT SUGGESTIONS

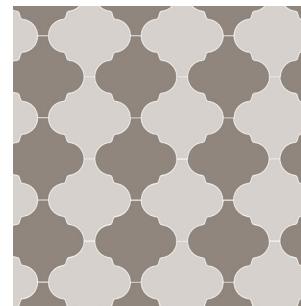
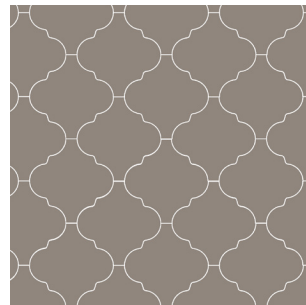

SPECIFICATIONS

WOOD TILE CONSTRUCTION:

Engineered wood.
4mm wear layer over 9 ply substrate.

THICKNESS:

5/8 inches.

REPEAT:

N/A

BOX QUANTITY:

22.05 SF per box.
150 tiles total per box

COVERAGE PER TILE:

.147 SF per tile.

INSTALLATION:

Glue down. (See installation guidelines)
Wood tiles are NOT provided on a mesh or panel backing.

USAGE:

Warranted for Commercial or Residential floors, walls & ceilings.
Not suitable for areas exposed to running water: inside showers, etc.
Not suitable for outdoor applications.

LEADTIME:

6-8 weeks for production.
Expedited options available upon request for an upcharge.

PRICING:

Varies by pattern & wood species.
Multiple stain selections do not affect pricing.

FIRE RATING:

Class C. (Class B available upon request)

STAINING SYSTEM:

Rubio Monocoat hard oil finish - no VOC.
Available unfinished.

LEED CREDITS:

2009 NC/CI MR Credit 5 - Regional Materials
2009 NC/CI IEQ Credit 4.1-4.4 - Low Emitting Finish

***This product may contribute to the achievement of LEED credits, although JBC makes no guarantees of representation of such.

CAD PATTERNS AVAILABLE UPON REQUEST.

Contact your local JBC representative.

3. SPECIES



Plain White Oak

Walnut



Quarter White

4. STAINS

AVAILABLE ON WHITE OAK SPECIES



Polished Amber

Dolphin

Smokey Quartz

Black Onyx

Grey Moonstone

Pickled Pearl

Mist

Gris

Slate

Sapphire

AVAILABLE ON WALNUT SPECIES:

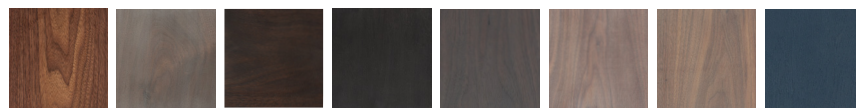

Polished Amber

Dolphin

Smokey Quartz

Black Onyx

Grey Moonstone

Pickled Pearl

Mist

Sapphire

swoop

ENIGMA COLLECTION FOR FLOORS, WALLS & CEILINGS



JAMIE BECKWITH®
COLLECTION

1. PATTERN AND REPEAT

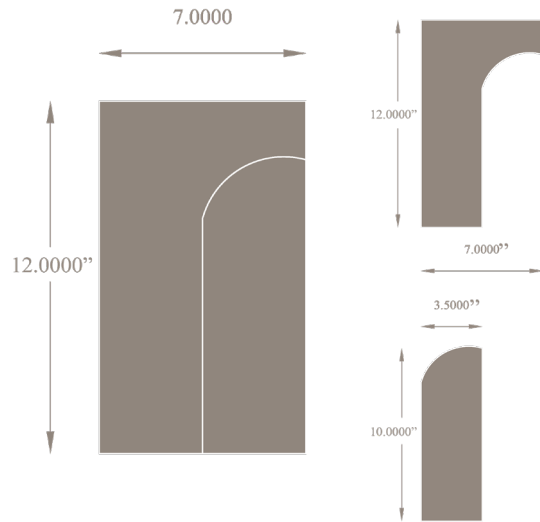

2. LAYOUT SUGGESTIONS

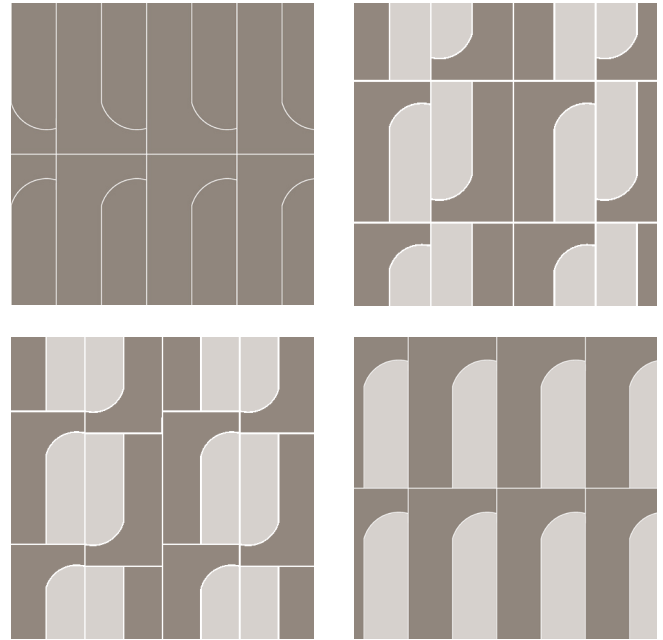

SPECIFICATIONS

WOOD TILE CONSTRUCTION:

Engineered wood.
4mm wear layer over 9 ply substrate.

THICKNESS:

5/8 inches.

REPEAT:

2 Tiles: .583 SF

BOX QUANTITY:

23.32 SF per box.
80 tiles total per box/ 40 repeats.

COVERAGE PER TILE:

Varies

INSTALLATION:

Glue down. (See installation guidelines)
Wood tiles are NOT provided on a mesh or panel backing.

USAGE:

Warranted for Commercial or Residential floors, walls & ceilings.
Not suitable for areas exposed to running water: inside showers, etc.
Not suitable for outdoor applications.

LEADTIME:

6-8 weeks for production.
Expedited options available upon request for an upcharge.

PRICING:

Varies by pattern & wood species.
Multiple stain selections do not affect pricing.

FIRE RATING:

Class C. (Class B available upon request)

STAINING SYSTEM:

Rubio Monocoat hard oil finish - no VOC.
Available unfinished.

LEED CREDITS:

2009 NC/CI MR Credit 5 - Regional Materials
2009 NC/CI IEQ Credit 4.1-4.4 - Low Emitting Finish

***This product may contribute to the achievement of LEED credits, although JBC makes no guarantees of representation of such.

CAD PATTERNS AVAILABLE UPON REQUEST.

Contact your local JBC representative.

3. SPECIES



Plain White Oak

Walnut



Quarter White

4. STAINS

AVAILABLE ON WHITE OAK SPECIES



Polished Amber

Dolphin

Smokey Quartz

Black Onyx

Grey Moonstone

Pickled Pearl

Mist

Gris

Slate

Sapphire

AVAILABLE ON WALNUT SPECIES:



Polished Amber

Dolphin

Smokey Quartz

Black Onyx

Grey Moonstone

Pickled Pearl

Mist

Sapphire

insignia

ENIGMA COLLECTION FOR FLOORS, WALLS & CEILINGS



JAMIE BECKWITH®
COLLECTION

1. PATTERN AND REPEAT

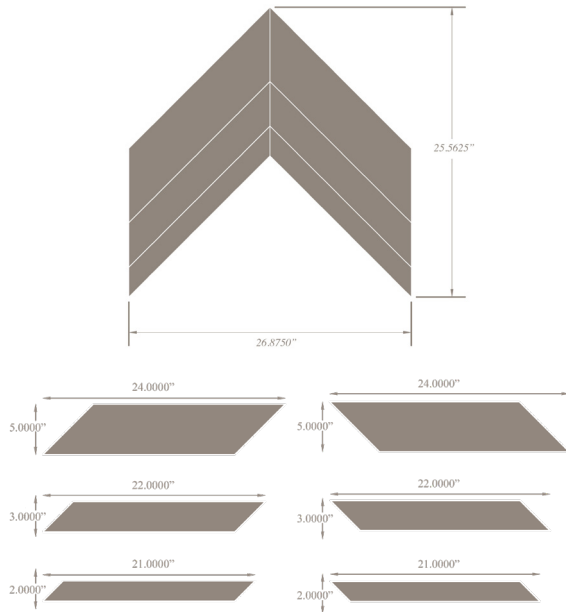

2. LAYOUT SUGGESTIONS

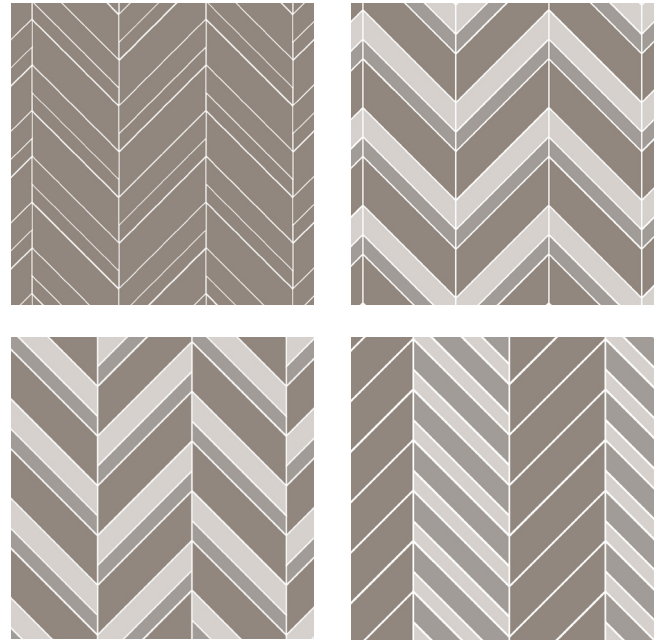

SPECIFICATIONS

WOOD TILE CONSTRUCTION:

Engineered wood.
4mm wear layer over 9 ply substrate.

THICKNESS:

5/8 inches.

REPEAT:

6 Planks: 2.64 SF
Right and Left for each width

BOX QUANTITY:

21.12 SF per box.
48 Planks total per box/ 8 repeats.

COVERAGE PER TILE:

Varies

INSTALLATION:

Glue down. (See installation guidelines)
Wood tiles are NOT provided on a mesh or panel backing.

USAGE:

Warranted for Commercial or Residential floors, walls & ceilings.
Not suitable for areas exposed to running water: inside showers, etc.
Not suitable for outdoor applications.

LEADTIME:

6-8 weeks for production.
Expedited options available upon request for an upcharge.

PRICING:

Varies by pattern & wood species.
Multiple stain selections do not affect pricing.

FIRE RATING:

Class C. (Class B available upon request)

STAINING SYSTEM:

Rubio Monocoat hard oil finish - no VOC.
Available unfinished.

LEED CREDITS:

2009 NC/CI MR Credit 5 - Regional Materials
2009 NC/CI IEQ Credit 4.1-4.4 - Low Emitting Finish

***This product may contribute to the achievement of LEED credits, although JBC makes no guarantees of representation of such.

CAD PATTERNS AVAILABLE UPON REQUEST.

Contact your local JBC representative.

3. SPECIES



Plain White Oak

Walnut



Quarter White

4. STAINS

AVAILABLE ON WHITE OAK SPECIES



Polished Amber

Dolphin

Smokey Quartz

Black Onyx

Grey Moonstone

Pickled Pearl

Mist

Gris

Slate

Sapphire

AVAILABLE ON WALNUT SPECIES:



Polished Amber

Dolphin

Smokey Quartz

Black Onyx

Grey Moonstone

Pickled Pearl

Mist

Sapphire

1. PATTERN AND REPEAT

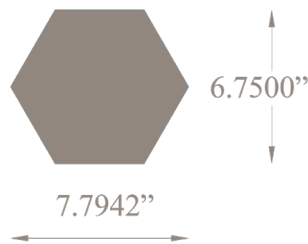

2. LAYOUT SUGGESTIONS

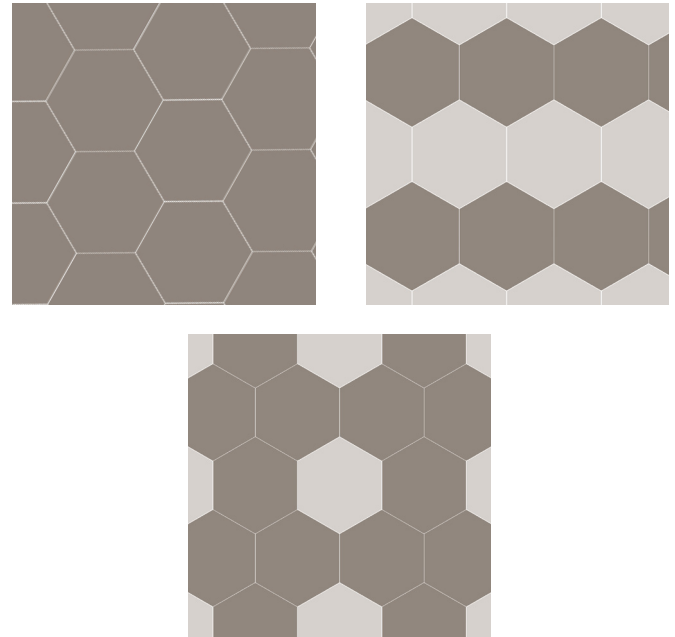

SPECIFICATIONS

WOOD TILE CONSTRUCTION:

Engineered wood.
4mm wear layer over 9 ply substrate.

THICKNESS:

5/8 inches.

REPEAT:

N/A

BOX QUANTITY:

21.098 SF per box.
77 tiles total per box

COVERAGE PER TILE:

.274 SF per tile.

INSTALLATION:

Glue down. (See installation guidelines)
Wood tiles are NOT provided on a mesh or panel backing.

USAGE:

Warranted for Commercial or Residential floors, walls & ceilings.
Not suitable for areas exposed to running water: inside showers, etc.
Not suitable for outdoor applications.

LEADTIME:

6-8 weeks for production.
Expedited options available upon request for an upcharge.

PRICING:

Varies by pattern & wood species.
Multiple stain selections do not affect pricing.

FIRE RATING:

Class C. (Class B available upon request)

STAINING SYSTEM:

Rubio Monocoat hard oil finish - no VOC.
Available unfinished.

LEED CREDITS:

2009 NC/CI MR Credit 5 - Regional Materials
2009 NC/CI IEQ Credit 4.1-4.4 - Low Emitting Finish

***This product may contribute to the achievement of LEED credits, although JBC makes no guarantees of representation of such.

CAD PATTERNS AVAILABLE UPON REQUEST.

Contact your local JBC representative.

3. SPECIES



Plain White Oak

Walnut



Quarter White

4. STAINS

AVAILABLE ON WHITE OAK SPECIES



Polished Amber

Dolphin

Smokey Quartz

Black Onyx

Grey Moonstone

Pickled Pearl

Mist

Gris

Slate

Sapphire

AVAILABLE ON WALNUT SPECIES:



Polished Amber

Dolphin

Smokey Quartz

Black Onyx

Grey Moonstone

Pickled Pearl

Mist

Sapphire

wave

ENIGMA COLLECTION FOR FLOORS, WALLS & CEILINGS



JAMIE BECKWITH®
COLLECTION

1. PATTERN AND REPEAT

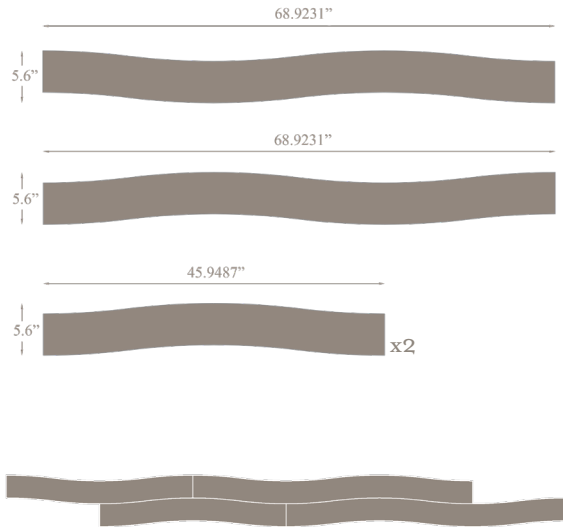

2. LAYOUT SUGGESTIONS

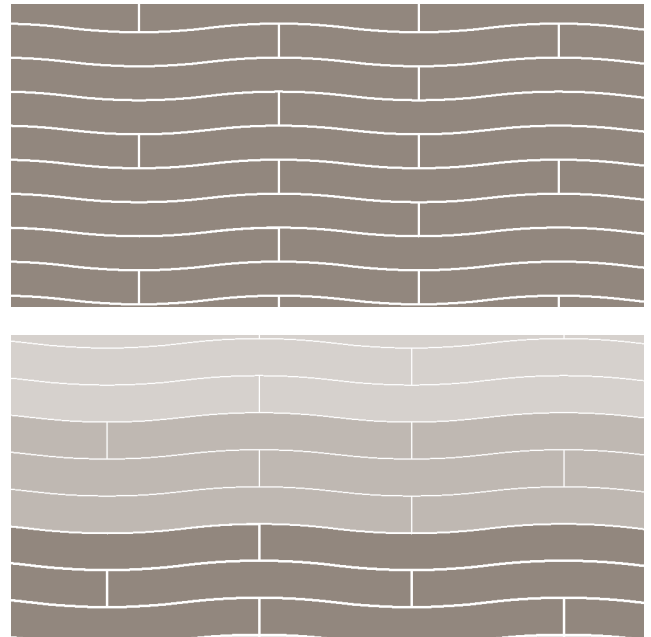

SPECIFICATIONS

WOOD TILE CONSTRUCTION:

Engineered wood.
4mm wear layer over 9 ply substrate.

THICKNESS:

5/8 inches.

REPEAT:

4 Planks: 8.794 SF
2 Large (1 left & 1 right) & 2 Mediums.

BOX QUANTITY:

26.64 SF per box.
12 planks total per box/ 3 repeats.

COVERAGE PER TILE:

Varies

INSTALLATION:

Glue down. (See installation guidelines)
Wood tiles are NOT provided on a mesh or panel backing.

USAGE:

Warranted for Commercial or Residential floors, walls & ceilings.
Not suitable for areas exposed to running water: inside showers, etc.
Not suitable for outdoor applications.

LEADTIME:

6-8 weeks for production.
Expedited options available upon request for an upcharge.

PRICING:

Varies by pattern & wood species.
Multiple stain selections do not affect pricing.

FIRE RATING:

Class C. (Class B available upon request)

STAINING SYSTEM:

Rubio Monocoat hard oil finish - no VOC.
Available unfinished.

LEED CREDITS:

2009 NC/CI MR Credit 5 - Regional Materials
2009 NC/CI IEQ Credit 4.1-4.4 - Low Emitting Finish

***This product may contribute to the achievement of LEED credits, although JBC makes no guarantees of representation of such.

CAD PATTERNS AVAILABLE UPON REQUEST.

Contact your local JBC representative.

3. SPECIES



Plain White Oak

Walnut



Quarter White

4. STAINS

AVAILABLE ON WHITE OAK SPECIES



Polished Amber

Dolphin

Smokey Quartz

Black Onyx

Grey Moonstone

Pickled Pearl

Mist

Gris

Slate

Sapphire

AVAILABLE ON WALNUT SPECIES:

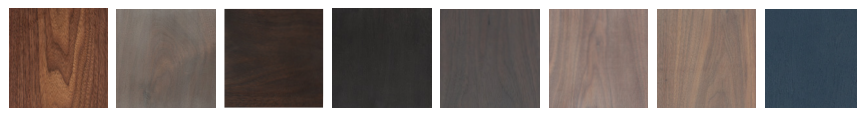

Polished Amber

Dolphin

Smokey Quartz

Black Onyx

Grey Moonstone

Pickled Pearl

Mist

Sapphire

chained

ENIGMA COLLECTION FOR FLOORS, WALLS & CEILINGS



JAMIE BECKWITH®
COLLECTION

1. PATTERN AND REPEAT

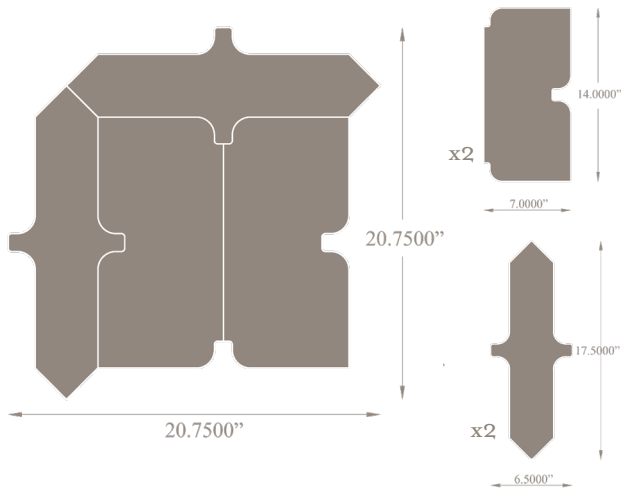

2. LAYOUT SUGGESTIONS

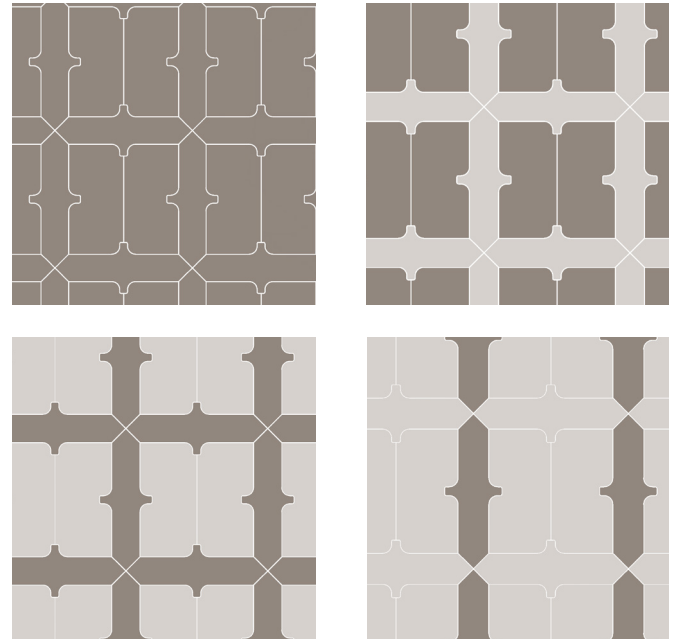

SPECIFICATIONS

WOOD TILE CONSTRUCTION:

Engineered wood.
4mm wear layer over 9 ply substrate.

THICKNESS:

5/8 inches.

REPEAT:

4 Pieces: 2.130 SF
2 Center tiles & 2 border tiles

BOX QUANTITY:

21.3 SF per box.
40 Tiles per box/ 10 repeats.

COVERAGE PER TILE:

Varies

INSTALLATION:

Glue down. (See installation guidelines)
Wood tiles are NOT provided on a mesh or panel backing.

USAGE:

Warranted for Commercial or Residential floors, walls & ceilings.
Not suitable for areas exposed to running water: inside showers, etc.
Not suitable for outdoor applications.

LEADTIME:

6-8 weeks for production.
Expedited options available upon request for an upcharge.

PRICING:

Varies by pattern & wood species.
Multiple stain selections do not affect pricing.

FIRE RATING:

Class C. (Class B available upon request)

STAINING SYSTEM:

Rubio Monocoat hard oil finish - no VOC.
Available unfinished.

LEED CREDITS:

2009 NC/CI MR Credit 5 - Regional Materials
2009 NC/CI IEQ Credit 4.1-4.4 - Low Emitting Finish

***This product may contribute to the achievement of LEED credits, although JBC makes no guarantees of representation of such.

CAD PATTERNS AVAILABLE UPON REQUEST.

Contact your local JBC representative.

3. SPECIES



Plain White Oak

Walnut



Quarter White

4. STAINS

AVAILABLE ON WHITE OAK SPECIES



Polished Amber

Dolphin

Smokey Quartz

Black Onyx

Grey Moonstone

Pickled Pearl

Mist

Gris

Slate

Sapphire

AVAILABLE ON WALNUT SPECIES:

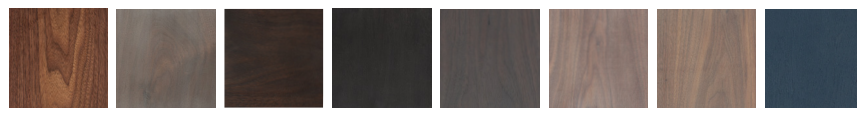

Polished Amber

Dolphin

Smokey Quartz

Black Onyx

Grey Moonstone

Pickled Pearl

Mist

Sapphire

jacks

ENIGMA COLLECTION FOR FLOORS, WALLS & CEILINGS



JAMIE BECKWITH®
COLLECTION

1. PATTERN AND REPEAT

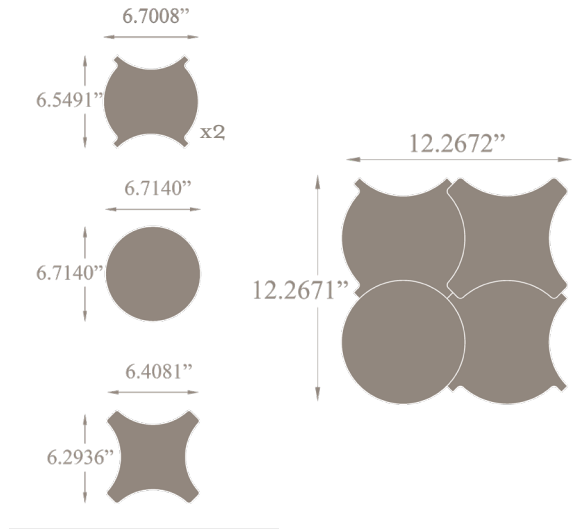

2. LAYOUT SUGGESTIONS

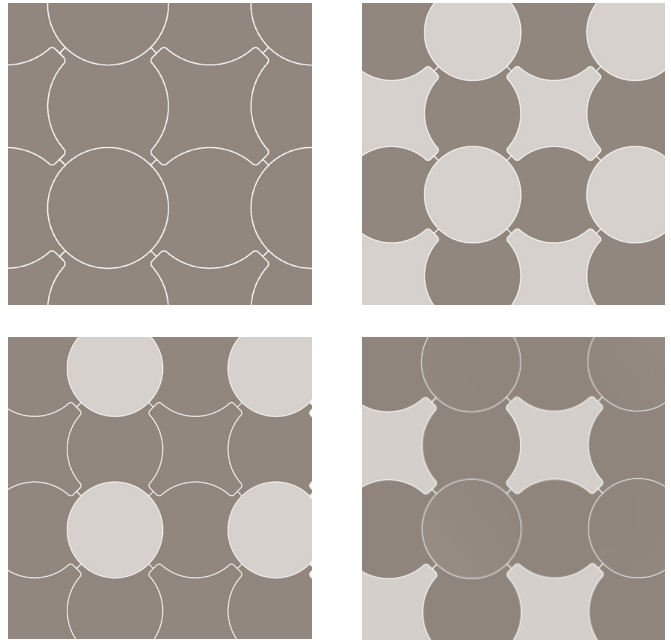

SPECIFICATIONS

WOOD TILE CONSTRUCTION:

Engineered wood.
4mm wear layer over 9 ply substrate.

THICKNESS:

5/8 inches.

REPEAT:

4 Tiles: .885 SF
2 turtles, 1 star, 1 circle

BOX QUANTITY:

18.585 SF per box.
84 tiles total per box/ 21 repeats.

COVERAGE PER TILE:

Varies

INSTALLATION:

Glue down. (See installation guidelines)
Wood tiles are NOT provided on a mesh or panel backing.

USAGE:

Warranted for Commercial or Residential floors, walls & ceilings.
Not suitable for areas exposed to running water: inside showers, etc.
Not suitable for outdoor applications.

LEADTIME:

6-8 weeks for production.
Expedited options available upon request for an upcharge.

PRICING:

Varies by pattern & wood species.
Multiple stain selections do not affect pricing.

FIRE RATING:

Class C. (Class B available upon request)

STAINING SYSTEM:

Rubio Monocoat hard oil finish - no VOC.
Available unfinished.

LEED CREDITS:

2009 NC/CI MR Credit 5 - Regional Materials
2009 NC/CI IEQ Credit 4.1-4.4 - Low Emitting Finish

***This product may contribute to the achievement of LEED credits, although JBC makes no guarantees of representation of such.

CAD PATTERNS AVAILABLE UPON REQUEST.

Contact your local JBC representative.

3. SPECIES



Plain White Oak

Walnut



Quarter White

4. STAINS

AVAILABLE ON WHITE OAK SPECIES



Polished Amber

Dolphin

Smokey Quartz

Black Onyx

Grey Moonstone

Pickled Pearl

Mist

Gris

Slate

Sapphire

AVAILABLE ON WALNUT SPECIES:

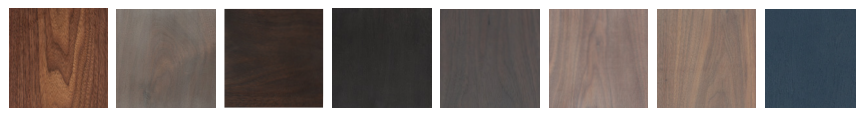

Polished Amber

Dolphin

Smokey Quartz

Black Onyx

Grey Moonstone

Pickled Pearl

Mist

Sapphire

jigsaw

ENIGMA COLLECTION FOR FLOORS, WALLS & CEILINGS



JAMIE BECKWITH®
COLLECTION

1. PATTERN AND REPEAT

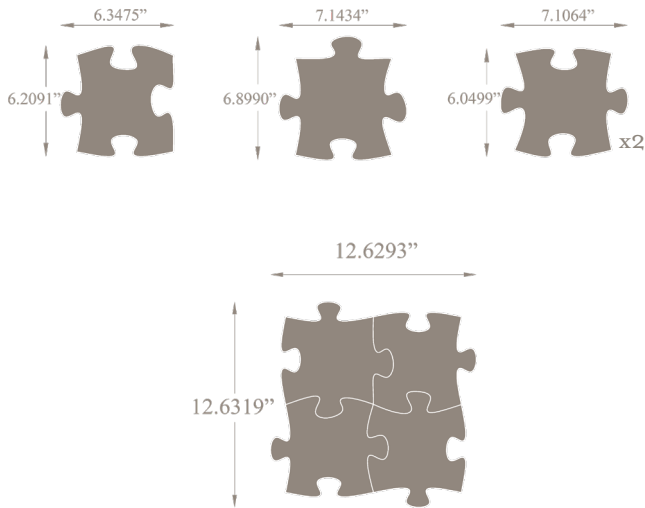

2. LAYOUT SUGGESTIONS

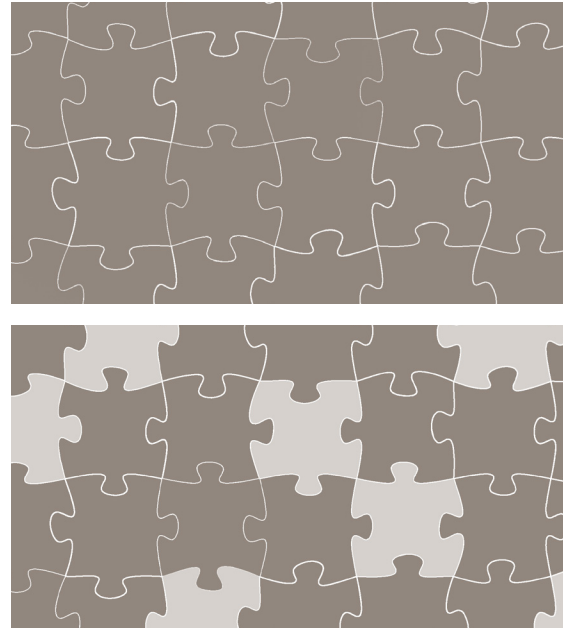

SPECIFICATIONS

WOOD TILE CONSTRUCTION:

Engineered wood.
4mm wear layer over 9 ply substrate.

THICKNESS:

5/8 inches.

REPEAT:

4 Tiles: .79 SF

BOX QUANTITY:

16.59 SF per box.
84 tiles total per box/ 21 repeats.

COVERAGE PER TILE:

Varies.

INSTALLATION:

Glue down. (See installation guidelines)
Wood tiles are NOT provided on a mesh or panel backing.

USAGE:

Warranted for Commercial or Residential floors, walls & ceilings.
Not suitable for areas exposed to running water: inside showers, etc.
Not suitable for outdoor applications.

LEADTIME:

6-8 weeks for production.
Expedited options available upon request for an upcharge.

PRICING:

Varies by pattern & wood species.
Multiple stain selections do not affect pricing.

FIRE RATING:

Class C. (Class B available upon request)

STAINING SYSTEM:

Rubio Monocoat hard oil finish - no VOC.
Available unfinished.

LEED CREDITS:

2009 NC/CI MR Credit 5 - Regional Materials
2009 NC/CI IEQ Credit 4.1-4.4 - Low Emitting Finish

***This product may contribute to the achievement of LEED credits, although JBC makes no guarantees of representation of such.

CAD PATTERNS AVAILABLE UPON REQUEST.

Contact your local JBC representative.

3. SPECIES



Plain White Oak

Walnut



Quarter White

4. STAINS

AVAILABLE ON WHITE OAK SPECIES



Polished Amber

Dolphin

Smokey Quartz

Black Onyx

Grey Moonstone

Pickled Pearl

Mist

Gris

Slate

Sapphire

AVAILABLE ON WALNUT SPECIES:

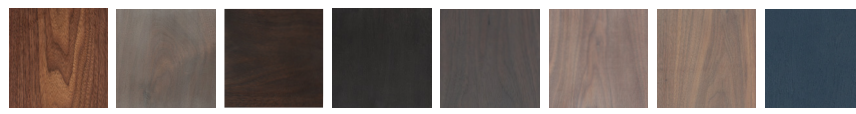

Polished Amber

Dolphin

Smokey Quartz

Black Onyx

Grey Moonstone

Pickled Pearl

Mist

Sapphire

kaleidoscope

ENIGMA COLLECTION FOR FLOORS, WALLS & CEILINGS



JAMIE BECKWITH®
COLLECTION

1. PATTERN AND REPEAT

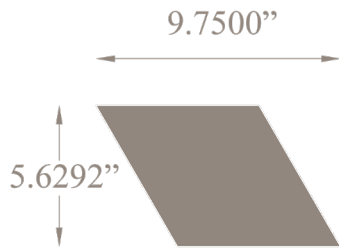

2. LAYOUT SUGGESTIONS

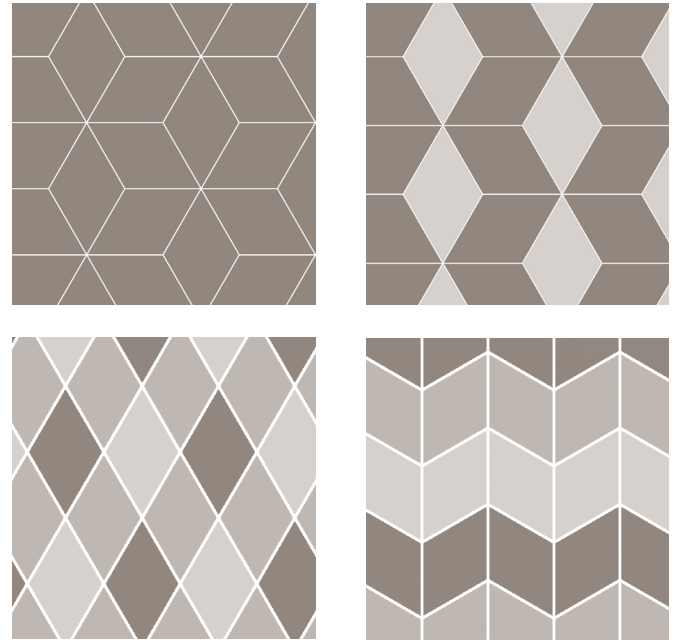

SPECIFICATIONS

WOOD TILE CONSTRUCTION:

Engineered wood.
4mm wear layer over 9 ply substrate.

THICKNESS:

5/8 inches.

REPEAT:

N/A

BOX QUANTITY:

19.812 SF per box.
78 tiles total per box.

COVERAGE PER TILE:

.254 SF

INSTALLATION:

Glue down. (See installation guidelines)
Wood tiles are NOT provided on a mesh or panel backing.

USAGE:

Warranted for Commercial or Residential floors, walls & ceilings.
Not suitable for areas exposed to running water: inside showers, etc.
Not suitable for outdoor applications.

LEADTIME:

6-8 weeks for production.
Expedited options available upon request for an upcharge.

PRICING:

Varies by pattern & wood species.
Multiple stain selections do not affect pricing.

FIRE RATING:

Class C. (Class B available upon request)

STAINING SYSTEM:

Rubio Monocoat hard oil finish - no VOC.
Available unfinished.

LEED CREDITS:

2009 NC/CI MR Credit 5 - Regional Materials
2009 NC/CI IEQ Credit 4.1-4.4 - Low Emitting Finish

***This product may contribute to the achievement of LEED credits, although JBC makes no guarantees of representation of such.

CAD PATTERNS AVAILABLE UPON REQUEST.

Contact your local JBC representative.

3. SPECIES



Plain White Oak

Walnut



Quarter White

4. STAINS

AVAILABLE ON WHITE OAK SPECIES



Polished Amber

Dolphin

Smokey Quartz

Black Onyx

Grey Moonstone

Pickled Pearl

Mist

Gris

Slate

Sapphire

AVAILABLE ON WALNUT SPECIES:

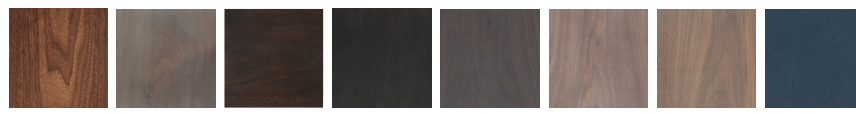

Polished Amber

Dolphin

Smokey Quartz

Black Onyx

Grey Moonstone

Pickled Pearl

Mist

Sapphire