



BLOOM

NOME:
Bloom

IT

DESCRIZIONE:
Miscela di fibre naturali e petali di fiori

APPLICAZIONI:
Vedi indicazione dei pannelli

CARATTERISTICHE:
Le superfici sono handcraft ed ogni singolo metro quadro è un po' diverso dall'altro grazie ai materiali naturali utilizzati, rendendo ogni superficie unica. Tutti i fiori e i petali stessi variano tra loro in forme e colori.

PESO TESSUTO:
0,13 kg/m²
0.026 lb/ft²

COMPOSIZIONE:
75% flax, 25% viscosa
Petalì di margherite, rose, fiordalisi, erica, lavanda, girasole e fieno

MANUTENZIONE:
Questo rivestimento in vere fibre naturali è quasi praticamente esente da manutenzione. In caso di necessità:

- Aspirare delicatamente con una bassa pressione.
- Superfici pregiate: passare un panno umido.
- Superfici medie e leggere: pulire delicatamente con un panno asciutto e privo di pelucchi.
- Evitare spazzole ruvide, detergenti aggressivi e prodotti chimici.

REAZIONE AL FUOCO:
Coming soon

CERTIFICAZIONI ECOLOGICHE:
Climate Partner

DURABILITÀ:

- Martinadale Pilling: 5000 UNI EN ISO 12945-2:2021 + UNI EN ISO 12945-4:2021
- Martinadale Abrasione: 1000 UNI EN ISO 12947-1:2000 + UNI EN ISO 12947-2:2017

FONO ASSORBIMENTO:
UNI EN ISO 354: 2003
UNI EN ISO 11654: 1998

NAME:
Bloom

EN

DESCRIPTION:
Blend of fibers natural and flower petals

APPLICATIONS:
See panel indication

CHARACTERISTICS:
The surfaces are handcrafted and each individual square metre is a little different from the next thanks to the natural materials used, making each surface unique. All the flowers and petals themselves vary in shape and colour.

FABRIC WEIGHT:
0,13 kg/m²
0.026 lb/ft²

COMPOSITION:
75% flax, 25% viscose
Petalìs of daisies, roses, cornflowers, heather, lavender, sunflowers and hay

MAINTENANCE:
This covering made of genuine natural fibres is virtually maintenance-free.
In case of need:

- Vacuum gently with low pressure.
- Fine surfaces: wipe with a damp cloth.
- Medium and light surfaces: wipe gently with a dry, lint-free cloth.
- Avoid rough brushes, aggressive cleaning agents and chemicals.

FIRE REACTION:
Coming soon

GREEN LABELS:
Climate Partner

DURABILITY:

- Martinadale Pilling: 5000 UNI EN ISO 12945-2:2021 + UNI EN ISO 12945-4:2021
- Martinadale Abrasion: 1000 UNI EN ISO 12947-1:2000 + UNI EN ISO 12947-2:2017

SOUND ABSORPTION:
UNI EN ISO 354: 2003
UNI EN ISO 11654: 1998

DENOMINATION:
Bloom

FR

DESCRIPTION:
Mélange de fibres naturelles fibres naturelles et pétales de fleurs

APPLICATION:
Voir l'indication du panneau

CARACTÉRISTIQUES :
Les surfaces sont fabriquées à la main et chaque mètre carré est légèrement différent de l'autre grâce aux matériaux naturels utilisés, ce qui rend chaque surface unique. Toutes les fleurs et tous les pétales varient en forme et en couleur.

POIDS DU TISSU:
0,13 kg/m²
0.026 lb/ft²

COMPOSITION:
75% lin, 25% viscose
Pétales de marguerites, de roses, de bleuets, de bruyère, de lavande, de tournesols et de foin

ENTRETIEN:
Ce revêtement en fibres naturelles authentiques ne nécessite aucun entretien.
En cas de besoin :

- Passez l'aspirateur à faible pression.
- Surfaces fines : essuyer avec un chiffon humide.
- Surfaces moyennes et légères : essuyez doucement avec un chiffon sec et non pelucheux.
- Évitez les brosses rugueuses, les produits de nettoyage agressifs et les produits chimiques.

REACTION AU FEU:
Coming soon

ÉTIQUETTES ÉCOLOGIQUES:
Climate Partner

DURABILITÉ:

- Martinadale Boulochage: 5000 UNI EN ISO 12945-2:2021 + UNI EN ISO 12945-4:2021
- Martinadale Abrasion: 1000 UNI EN ISO 12947-1:2000 + UNI EN ISO 12947-2:2017

ABSORPTION DU SON:
UNI EN ISO 354: 2003
UNI EN ISO 11654: 1998

NAME:
Bloom

DE

BESCHREIBUNG:
Mischung aus natürlichen Naturfasern und Blütenblättern

ANWENDUNG:
Siehe Tafelanzeige

EIGENSCHAFTEN:
Die Oberflächen sind handgefertigt und jeder Quadratmeter ist aufgrund der verwendeten Naturmaterialien unterschiedlich, was jede Oberfläche zu einem Unikat macht. Alle Blumen und Blütenblätter variieren in Form und Farbe.

GEWICHT DES GEWEBES:
0,13 kg/m²
0.026 lb/ft²

ZUSAMMENSETZUNG:
75% Leinen, 25% Viskose
Blütenblätter von Rosen, Lavendel, Heidekraut, Gänseblümchen, Kornblumen, Sonnenblumen und He

INSTANDHALTUNG:
Dieser Belag aus echten Naturfasern ist praktisch wartungsfrei.
Im Bedarfsfall:

- Vorsichtig mit geringem Druck absaugen.
- Feine Oberflächen: mit einem feuchten Tuch abwischen.
- Mittlere und helle Oberflächen: mit einem trockenen, fusselfreien Tuch vorsichtig abwischen.
- Vermeiden Sie raue Bürsten, aggressive Reinigungsmittel und Chemikalien.

BRANDVERHALTEN - KLASSE:
Coming soon

ÖKOLOGISCHE ZERTIFIZIERUNG:
Climate Partner

DURABILITÄT:

- Boulochage Pilling: 5000 UNI EN ISO 12945-2:2021 + UNI EN ISO 12945-4:2021
- Martinadale Abrieb: 1000 UNI EN ISO 12947-1:2000 + UNI EN ISO 12947-2:2017

SCHALLABSORPTION:
UNI EN ISO 354: 2003
UNI EN ISO 11654: 1998

NOMBRE:
Bloom

ES

DESCRIPCIÓN:
Mezcla de fibras fibras naturales y pétalos de flores

APLICACIONES:
Ver indicación del panel

CARACTERÍSTICAS:
Las superficies están hechas a mano y cada metro cuadrado es un poco diferente del siguiente gracias a los materiales naturales utilizados, lo que hace que cada superficie sea única. Todas las flores y pétalos varían en forma y color.

PESO DEL TEJIDO:
0,13 kg/m²
0.026 lb/ft²

COMPOSICIÓN:
75% lino, 25% viscosa
Pétalos de margaritas, rosas, acianos, brezo, lavanda, girasoles y heno

MANTENIMIENTO:
Este revestimiento de auténticas fibras naturales prácticamente no necesita mantenimiento.
En caso de necesidad:

- Aspire suavemente con baja presión.
- Superficies finas: limpie con un paño húmedo.
- Superficies medias y claras: pasar suavemente un paño seco y sin pelusas.
- Evite los cepillos ásperos, los productos de limpieza agresivos y los productos químicos.

REACCIÓN AL FUEGO:
Coming soon

CERTIFICACIONES ECOLÓGICAS:
Climate Partner

DURABILIDAD:

- Martinadale Pilling: 5000 UNI EN ISO 12945-2:2021 + UNI EN ISO 12945-4:2021
- Martinadale Abrasión: 1000 UNI EN ISO 12947-1:2000 + UNI EN ISO 12947-2:2017

ABSORCIÓN DE SONIDO:
UNI EN ISO 354: 2003
UNI EN ISO 11654: 1998

Bloom | Millerighe
 $\alpha_w = \text{coming soon}$

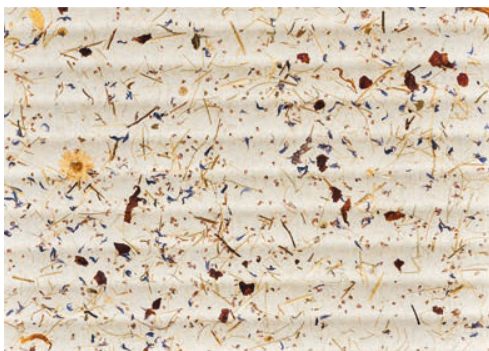

Bloom | ECOwall
 $\alpha_w = 0,35$





ECOWALL BLOOM

WALL/CEILING

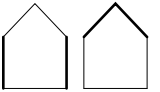

Front: CAT BLOOM

Back: Black

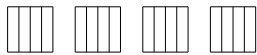

SET of 4
stesso colore
same color
du même couleur
gleiche Farbe
mismo color



velcro adesivo incluso
selfadhesive velcro included
bande Velcro inclus
Klettband enthalten
cinta de velcro incluidas

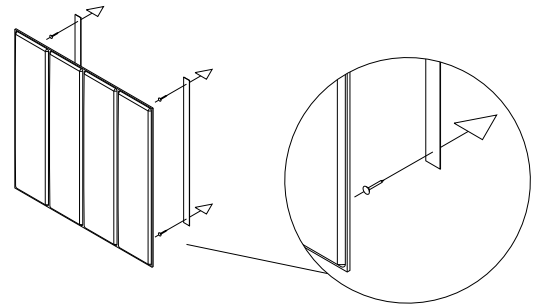
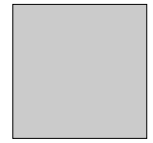
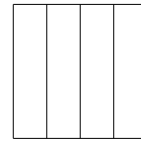
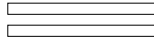

COD **EW-60.60/V/4**

CM 59,5x59,5x2

IN 23.4x23.4x0.8

CO CAT BLOOM

€

**Ideali se vuoi affiancare
i pannelli:**

*Ideal if you want to place
panels side by side:*

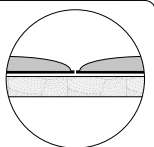

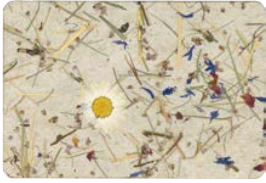

MILLERIGHE BLOOM

WALL/CEILING
BY ONSITESTUDIO

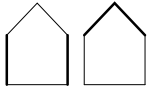

pannello monofacciale | single-sided panel
panneau à simple face | Einseitige Panel
panel mono-facial

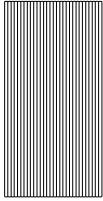

COD	MR-280.136/V
CM	136xH280x1,1
IN	53.5xH110.24x0.43
CO	CAT BLOOM
€	



velcro adesivo incluso
selfadhesive velcro included
bande Velcro inclus
Klettband enthalten
cinta de velcro incluidas

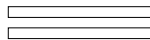

Front: CAT BLOOM

Back: Black

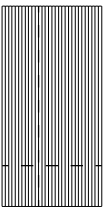
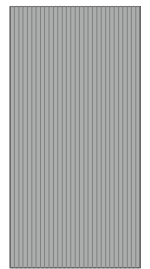
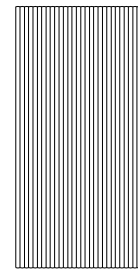

COD	MR/V - CUSTOM CUT
CM	CUSTOM
IN	CUSTOM
CO	CAT BLOOM
€	



velcro adesivo incluso
selfadhesive velcro included
bande Velcro inclus
Klettband enthalten
cinta de velcro incluidas

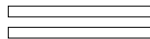

Section: Waves step

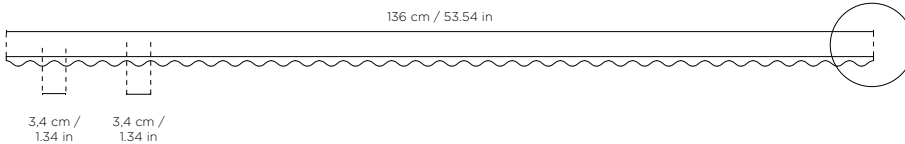

136 cm / 53.54 in

3,4 cm / 1.34 in 3,4 cm / 1.34 in

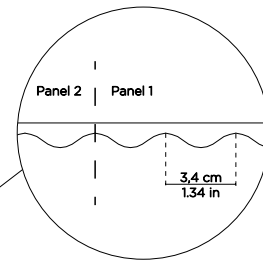

Axonometric view:

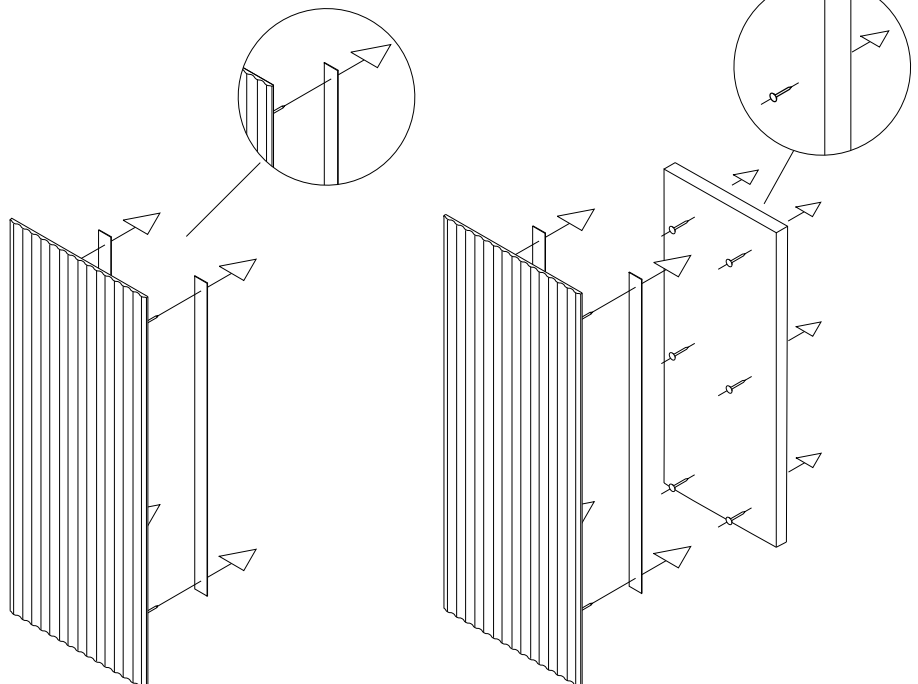

Vuoi personalizzare i tuoi pannelli?
Do you want to custom your panels?

Taglia il pannello solo tra 2 onde!
Cut the panel between 2 waves!

